



## Seven Channel Power Amplifier



## MC207 Owner's Manual

The lightning flash with arrowhead, within an equilateral triangle, is intended to alert the user to the presence of un-insulated “dangerous voltage” within the product’s enclosure that may be of sufficient magnitude to constitute a risk of electric shock to persons.



**AVIS** RISQUE DE CHOC ELECTRIQUE - NE PAS OUVRIR.

The exclamation point within an equilateral triangle is intended to alert the user to the presence of important operating and maintenance (servicing) instructions in the literature accompanying the appliance.

**WARNING - TO REDUCE RISK OF FIRE OR ELECTRICAL SHOCK, DO NOT EXPOSE THIS EQUIPMENT TO RAIN OR MOISTURE.**

**NO USER-SERVICEABLE PARTS INSIDE. REFER SERVICING TO QUALIFIED PERSONNEL.**

To prevent the risk of electric shock, do not remove cover or back. No user-serviceable parts inside.

## IMPORTANT SAFETY INSTRUCTIONS!

**PLEASE READ THEM BEFORE OPERATING THIS EQUIPMENT.**

1. Read these instructions.
2. Keep these instructions.
3. Heed all warnings.
4. Follow all instructions.
5. Do not use this apparatus near water.
6. Clean only with a dry cloth.
7. Do not block any ventilation openings. Install in accordance with the manufacturer’s instructions.
8. Do not install near any heat sources such as radiators, heat registers, stoves, or other apparatus (including amplifiers) that produce heat.
9. Do not defeat the safety purpose of the polarized or grounding-type plug. A polarized plug has two blades with one wider than the other. A grounding type plug has two blades and a third grounding prong. The wide blade or the third prong are provided for your safety. If the provided plug does not fit into your outlet, consult an electrician for replacement of the obsolete outlet.
10. Protect the power cord from being walked on or pinched particularly at plugs, convenience receptacles, and the point where they exit from the apparatus.
11. Only use attachments/accessories specified by the manufacturer.
12. Use only with the cart, stand, tripod, bracket, or table specified by the manufacturer, or sold with the apparatus. When a cart is used, use caution when moving the cart/apparatus combination to avoid injury from tip-over. 
13. Unplug this apparatus during lightning storms or when unused for long periods of time.
14. Refer all servicing to qualified service personnel. Servicing is required when the apparatus has been damaged in any way, such as power-supply cord or plug is damaged, liquid has been spilled or objects have fallen into the apparatus, the apparatus has been exposed to rain or moisture, does not operate normally, or has been dropped.
15. Do not expose this equipment to dripping or splashing and ensure that no objects filled with liquids, such as vases, are placed on the equipment.
16. To completely disconnect this equipment from the a.c. mains, disconnect the power supply cord plug from the a.c. receptacle.
17. The mains plug of the power supply cord shall remain readily operable.

## Thank You

Your decision to own this McIntosh MC207 Seven Channel Power Amplifier ranks you at the very top among discriminating music listeners. You now have “The Best.” The McIntosh dedication to “Quality,” is assurance that you will receive many years of musical enjoyment from this unit.

Please take a short time to read the information in this manual. We want you to be as familiar as possible with all the features and functions of your new McIntosh.

## Please Take A Moment

The serial number, purchase date and McIntosh Dealer name are important to you for possible insurance claim or future service. The spaces below have been provided for you to record that information:

**Serial Number:** \_\_\_\_\_

**Purchase Date:** \_\_\_\_\_

**Dealer Name:** \_\_\_\_\_

## Technical Assistance

If at any time you have questions about your McIntosh product, contact your McIntosh Dealer who is familiar with your McIntosh equipment and any other brands that may be part of your system. If you or your Dealer wish additional help concerning a suspected problem, you can receive technical assistance for all McIntosh products at:

McIntosh Laboratory, Inc.  
2 Chambers Street  
Binghamton, New York 13903  
Phone: 607-723-1545  
Fax: 607-723-3636

## Customer Service

If it is determined that your McIntosh product is in need of repair, you can return it to your Dealer. You can also return it to the McIntosh Laboratory Service Department. For assistance on factory repair return procedure, contact the McIntosh Service Department at:

McIntosh Laboratory, Inc.  
2 Chambers Street  
Binghamton, New York 13903  
Phone: 607-723-3515  
Fax: 607-723-1917

## Table of Contents

Safety Instructions .....	2
Thank You and Please Take a Moment .....	3
Technical Assistance and Customer Service .....	3
Table of Contents .....	3
Important Information .....	3
Connector Information .....	4
Introduction .....	4
Performance Features .....	4
Dimensions .....	5
Installation .....	6
Rear Panel Connections .....	7
How to Connect for Seven Channels .....	8
How to Connect for Five Channels .....	10
How to Connect for Two Channels (Zone B) .....	12
Front Panel Displays and Controls .....	14
How to Operate and Read the Power Output Meters .....	15
Technical Description .....	16-20
Specifications .....	22
Packing Instruction .....	23

## Important Information

1. For additional connection information, refer to the owner's manual(s) for any component(s) connected to the MC207.
2. The MC207 mutes the speaker outputs for approximately two seconds when first turned on.
3. It is very important that loudspeaker cables of adequate size be used, so that there will be no power loss. The size is specified in Gauge Numbers or AWG (American Wire Gauge). The smaller the Gauge number, the larger the wire size. The MC207 Loudspeaker Connection Terminals will accept up to a 10 AWG wire size:  
*If your loudspeaker cables are 50 feet (38.1m) or less, use at least 14 Gauge.*  
*If your loudspeaker cables are 100 feet (76.2m) or less, use at least 12 Gauge.*
4. In the event that the MC207 overheats, due to improper ventilation and/or high ambient temperature, the protection circuits will activate. The Front Panel Power Guard LEDs will continuously indicate ON and the audio will be muted. When the MC207 has returned to a safe operating temperature, normal operation will resume.
5. The Multi-Channel Input DB25 Connector allows for easy connecting of a McIntosh A/V Control Center, including the Audio and Power Control signals, to the MC207.
5. When discarding the unit, comply with local rules or regulations. Batteries should never be thrown away or incinerated but disposed of in accordance with the local regulations concerning battery disposal.
6. For additional information on the MC207 and other McIntosh Products please visit the McIntosh Web Site at [www.mcintoshlabs.com](http://www.mcintoshlabs.com).





## Connector Information

### XLR Connectors

Below is the Pin configuration for the XLR Balanced Input Connectors on the MC207. Refer to the diagram for connection:

- PIN 1: Shield/Ground
- PIN 2: + Input
- PIN 3: - Input

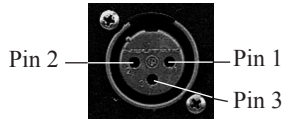

### Power Control and Trigger Connectors

The MC207's Power Control Outputs provide a 5 volt signal. Use a 1/8 inch stereo mini phone plug to connect to the Power Control Input on other McIntosh Components.

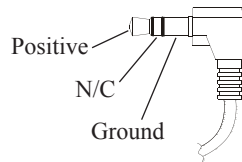

### Multi-Channel Amp DB25 Connector Pin Layout

- |                          |                              |
|--------------------------|------------------------------|
| 1. Left Front +          | 15. Center Front Gnd.        |
| 2. Center Front +        | 16. Right Front Gnd.         |
| 3. Right Front +         | 17. N/C                      |
| 4. N/C                   | 18. Left Surround Gnd.       |
| 5. Left Surround +       | 19. Right Surround Gnd.      |
| 6. Right Surround +      | 20. Left Back Surround Gnd.  |
| 7. Left Back Surround +  | 21. Right Back Surround Gnd. |
| 8. Right Back Surround + | 22. N/C                      |
| 9. N/C                   | 23. N/C                      |
| 10. N/C                  | 24. System Calibrate Gnd.    |
| 11. N/C                  | 25. Power Control Gnd.       |
| 12. System Calibrate     |                              |
| 13. Power Control In     |                              |
| 14. Left Front Gnd.      |                              |

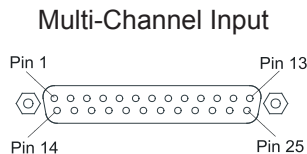

## Introduction

Now you can take advantage of traditional McIntosh standards of excellence in the MC207 Power Amplifier. Seven 200 watt high current output channels will drive any high quality Loudspeaker System to its ultimate performance. The MC207 reproduction is sonically transparent and absolutely accurate. The McIntosh Sound is "The Sound of the Music Itself."

## Performance Features

### • Power Output

The MC207 consists of seven Power Amplifier Channels, each capable of 200 watts into 4 ohm or 8 ohm Loudspeakers with less than 0.005% distortion.

### • Patented Power Guard

The patented McIntosh Power Guard Circuit prevents the amplifier from being over driven into clipping, with its harsh distorted sound that can also damage your valuable Loudspeakers.

### • Dynamic Power Manager®

The MC207's Dynamic Power Manager (DPM) circuitry allows for the connection of either 4 ohm or 8 ohm Loudspeakers, while at the same time delivering identical power output. A peak output current of 25 amperes per channel ensures that it will successfully drive high quality Loudspeakers such as McIntosh for a truly exciting sound experience.

### • Balanced and Unbalanced Inputs

Balanced connections guard against induced noise and allow long cable runs without compromising sound quality.

### • Patented Sentry Monitor with Thermal Protection

McIntosh Sentry Monitor power output stage protection circuits ensure the MC207 will have a long and trouble free operating life. Built-in Thermal Protection Circuits guard against overheating.

### • Power Control

The McIntosh Power Control Circuit allows for remote turn-on of the MC207 Power Amplifier from a McIntosh A/V Control Center or Preamplifier for a single or dual Zone System.

### • Illuminated Power Meters

The Illuminated Power Output Watt Meters on the MC207 are peak responding, and indicate the power output of the Front Amplifier Channels. The Meter Illumination may be switched Off at any time.

### • Fiber Optic Solid State Front Panel Illumination

The Illumination of the Front Panel is accomplished by the combination of custom designed Fiber Optic Light Diffusers and Light Emitting Diodes (LEDs). This provides even Front Panel Illumination, together with the extra long life LEDs.

### • Glass Front Panel and Super Mirror Chassis Finish

The famous McIntosh Illuminated Glass Front Panel and the Stainless Steel Chassis with Super Mirror Finish ensure the pristine beauty of the MC207 will be retained for many years.

**Dimensions**

The following dimensions can assist in determining the best location for the MC207. There is additional information on the next page pertaining to installing the MC207 into cabinets.

**Front View of the MC207**



**Rear View of the MC207**

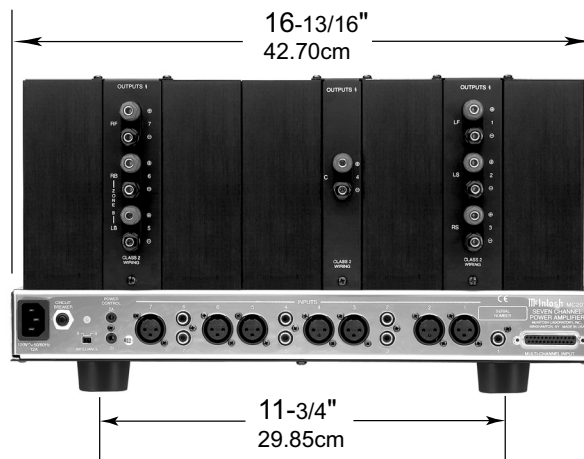

**Side View of the MC207**

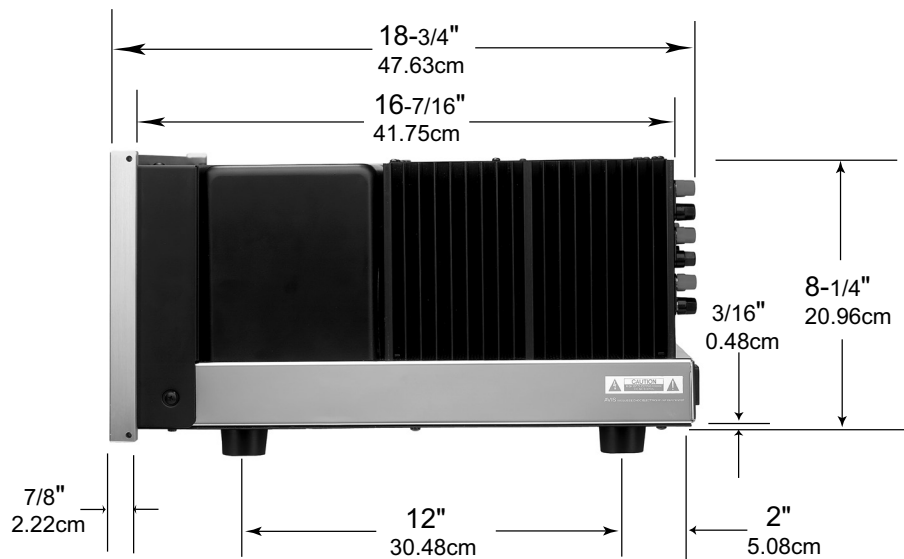

## Installation

The MC207 can be placed upright on a table or shelf, standing on its four feet. It also can be custom installed in a piece of furniture or cabinet of your choice. The four feet may be removed from the bottom of the MC207 when it is custom installed as outlined below. The four feet together with the mounting screws should be retained for possible future use if the MC207 is removed from the custom installation and used free standing. It also can be custom installed in a piece of furniture or cabinet of your choice

The required panel cutout, ventilation cutout and unit dimensions are shown.

Always provide adequate ventilation for your MC207.

Cool operation ensures the longest possible operating life for any electronic instrument. Do not install the MC207 directly above a heat generating component such as a high powered amplifier. If all the components are installed in a single cabinet, a quiet running ventilation fan can be a definite asset in maintaining all the system components at the coolest possible operating temperature.

A custom cabinet installation should provide the following minimum spacing dimensions for cool operation. Allow at least 6 inches (15.24cm) above the top, 2 inches (3.81cm) below the

bottom and 1 inch (2.54cm) on each side of the amplifier, so that airflow is not obstructed. Allow 20 inches (50.8cm) depth behind the front panel. Allow 1 inch (2.54cm) in front of the mounting panel for knob clearance. Be sure to cut out a ventilation hole in the mounting shelf according to the dimensions in the drawing.

**MC207 Front Panel Custom Cabinet Cutout**

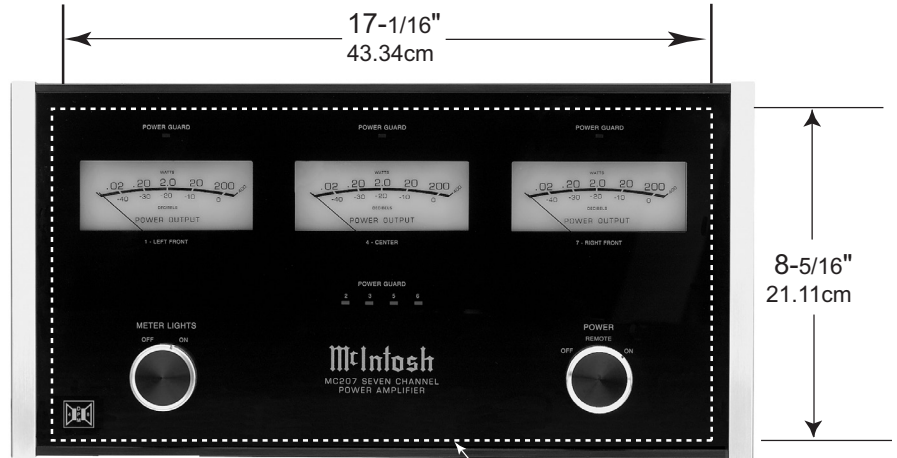

**MC207 Side View in Custom Cabinet**

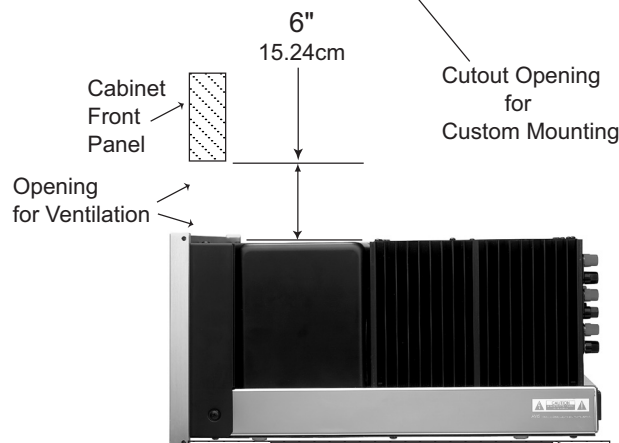

**MC207 Bottom View in Custom Cabinet**

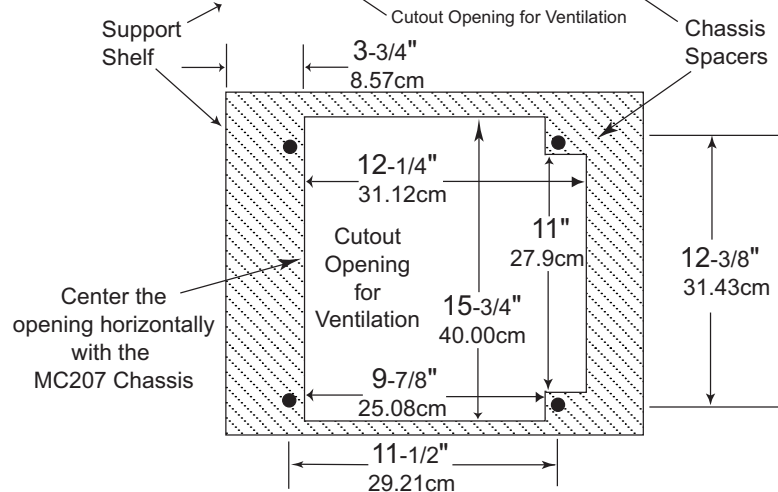

# Rear Panel Connections and Switch

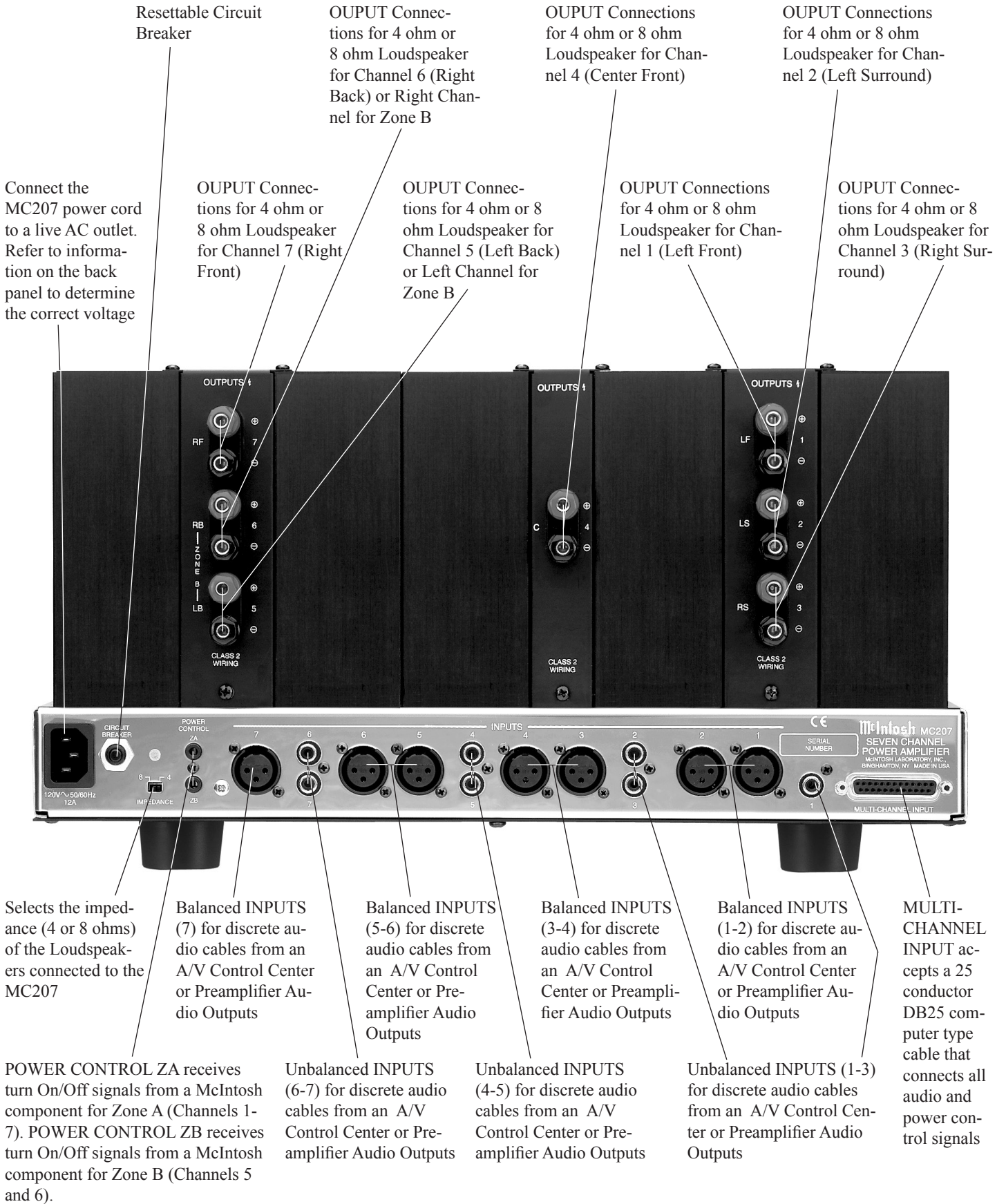



## How to Connect for Seven Channels

**Caution:** The supplied AC Power Cord should not be connected to the Rear Panel of the MC207 Amplifier until after the Loudspeaker Connections have been made. Failure to observe this could result in Electric Shock.

1. Connect Balanced Audio Cables from the Zone A Outputs of a McIntosh A/V Control Center to the MC207 INPUTS (Channels 1-7), making sure to match up the channel identifications between both units.

*Note: In place of the Balanced Audio Cables, unbalanced cables may be used. If a DB25 cable is used between the MULTI-CHANNEL INPUT of the MC207 and the Multi-Channel Output, the separate Power Control cable is not needed, proceed to step 3.*

2. For Remote Power Control and Power Saving Standby/Off (for additional information refer to page 15), connect a power control cable from the McIntosh A/V Control Center Zone A Power Control Out to the MC207 POWER CONTROL ZA.

3. Prepare the Loudspeaker Hookup Cables that attach to the MC207 Power Amplifier by choosing one of the methods below:

### Bare wire cable ends:

Carefully remove sufficient insulation from the cable ends, refer to figures 1, 2 & 3. If the cable is stranded, carefully twist the strands together as tightly as possible.

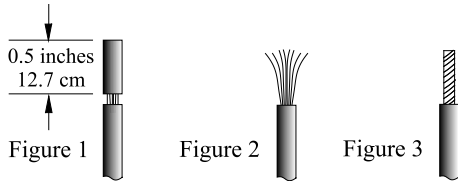

*Note: If desired, the twisted ends can be tinned with solder to keep the strands together, or attach spade lug and/or banana connector.*

### Spade lug or prepared wire connection:

Insert the spade lug connector or prepared section of the cable end into the terminal side access hole, and tighten the terminal cap until the cable is firmly clamped into the terminal so the wires cannot slip out. Refer to figures 4, 5 & 6.

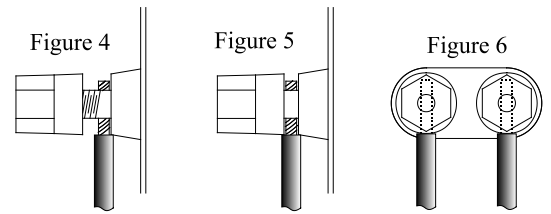

### Banana plug connection:

Tighten the top portion of the terminal post and insert the banana plug into the opening at the top of the terminal. Refer to figure 7.

*Note: The use of Banana Plugs is for use in the United States and Canada only.*

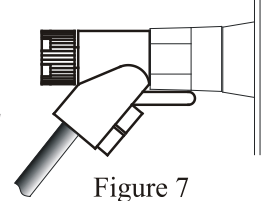

4. Connect the Loudspeaker Hookup Cables from the MC207 OUTPUT Terminals to the Loudspeakers, being careful to observe the correct polarities and channel designation.

**WARNING: Loudspeaker terminals are hazardous live and present a risk of electric shock. For additional instruction on making Loudspeaker Connections contact your McIntosh Dealer or McIntosh Technical Support.**

5. Place the IMPEDANCE Switch to the position (4 ohm or 8 ohm) that matches the impedance of the connected Loudspeakers. In the event that some of the Loudspeakers in the system are of different impedance, use the impedance of the Left and Right Front Loudspeakers to set the IMPEDANCE Switch position.
6. Connect the MC207 Power Cord to an active AC outlet.

McIntosh A/V Control Center





# How to Connect for Seven Channels

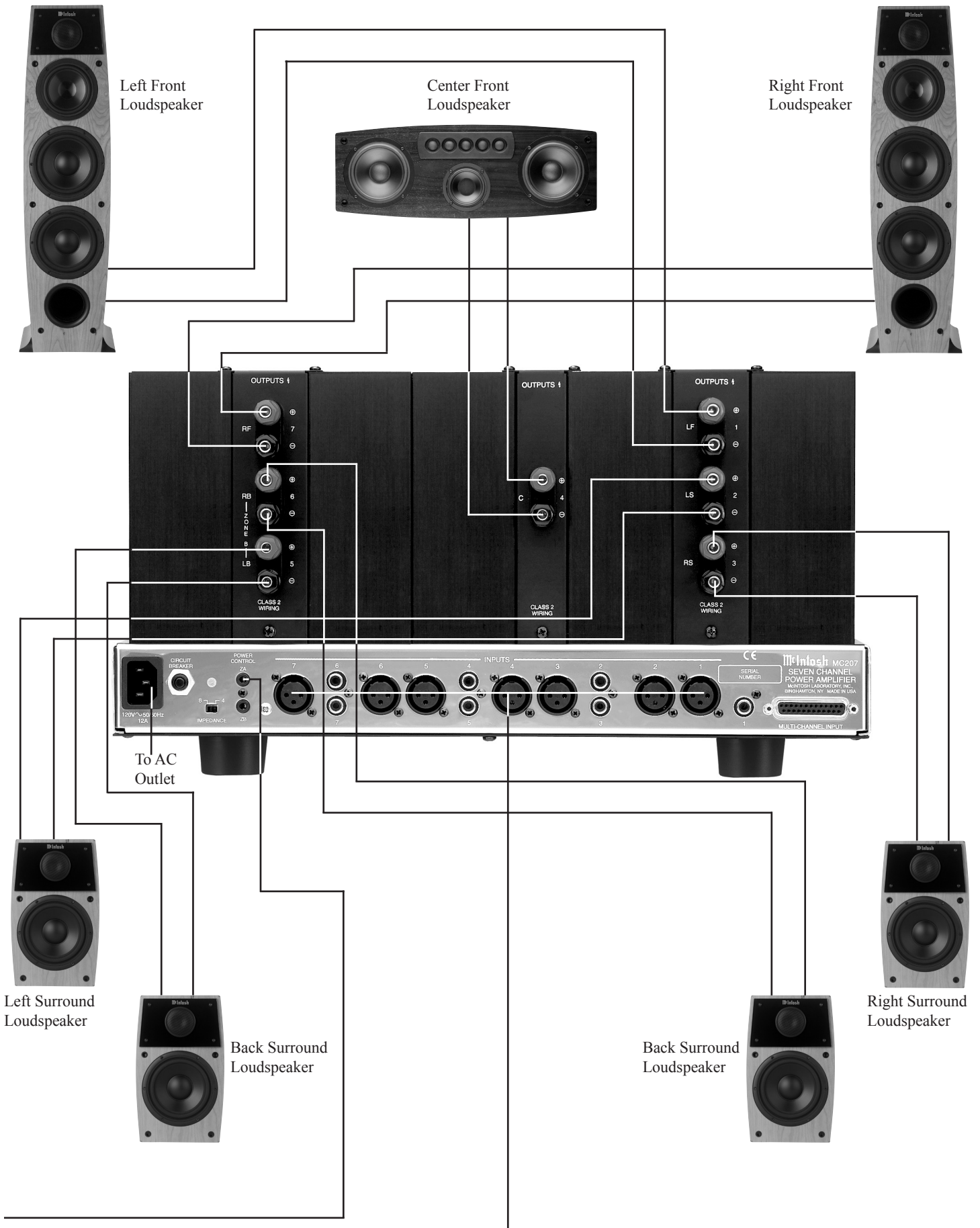



## How to Connect for Five Channels

**Caution:** The supplied AC Power Cord should not be connected to the Rear Panel of the MC207 Amplifier until after the Loudspeaker Connections have been made. Failure to observe this could result in Electric Shock.

1. Connect Balanced Audio Cables from the Zone A Outputs of a McIntosh A/V Control Center to the MC207 INPUTS (Channels 1-4 and 7), making sure to match up the channel identifications between both units.

*Note: In place of the Balanced Audio Cables, unbalanced cables may be used. If a DB25 cable is used between the MULTI-CHANNEL INPUT of the MC207 and the Multi-Channel Output, the separate Power Control Cable ZA is not needed.*

2. For Remote Power Control and Power Saving Standby/Off (for additional information refer to page 15), connect a power control cable from the McIntosh A/V Control Center Zone A Power Control Out to the MC207 POWER CONTROL ZA.

3. Prepare the Loudspeaker Hookup Cables that attach to the MC207 Power Amplifier by choosing one of the methods below:

### Bare wire cable ends:

Carefully remove sufficient insulation from the cable ends, refer to figures 1, 2 & 3. If the cable is stranded, carefully twist the strands together as tightly as possible.

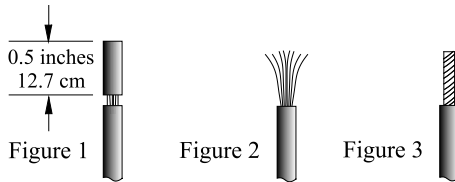

*Note: If desired, the twisted ends can be tinned with solder to keep the strands together, or attach spade lug and/or banana connector.*

### Spade lug or prepared wire connection:

Insert the spade lug connector or prepared section of the cable end into the terminal side access hole, and tighten the terminal cap until the cable is firmly clamped into the terminal so the wires cannot slip out. Refer to figures 4, 5 & 6.

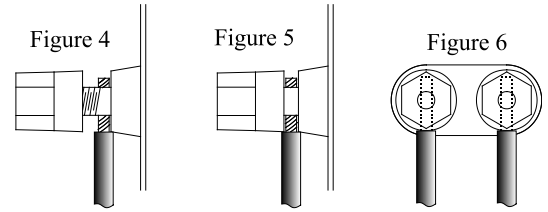

### Banana plug connection:

Tighten the top portion of the terminal post and insert the banana plug into the opening at the top of the terminal. Refer to figure 7.

*Note: The use of Banana Plugs is for use in the United States and Canada only.*

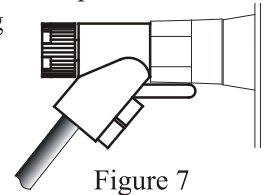

4. Connect the Loudspeaker Hookup Cables from the MC207 OUTPUT Terminals to the Loudspeakers, being careful to observe the correct polarities and channel designation.

**WARNING: Loudspeaker terminals are hazardous live and present a risk of electric shock. For additional instruction on making Loudspeaker Connections contact your McIntosh Dealer or McIntosh Technical Support.**

5. Place the IMPEDANCE Switch to the position (4 ohm or 8 ohm) that matches the impedance of the connected Loudspeakers. In the event that some of the Loudspeakers in the system are of different impedance, use the impedance of the Left and Right Front Loudspeakers to set the IMPEDANCE Switch position.

*Note: If the two remaining channels (5 and 6) are to be used for Zone B operation, proceed to page 12.*

6. Connect the MC207 Power Cord to an active AC outlet.

McIntosh A/V Control Center

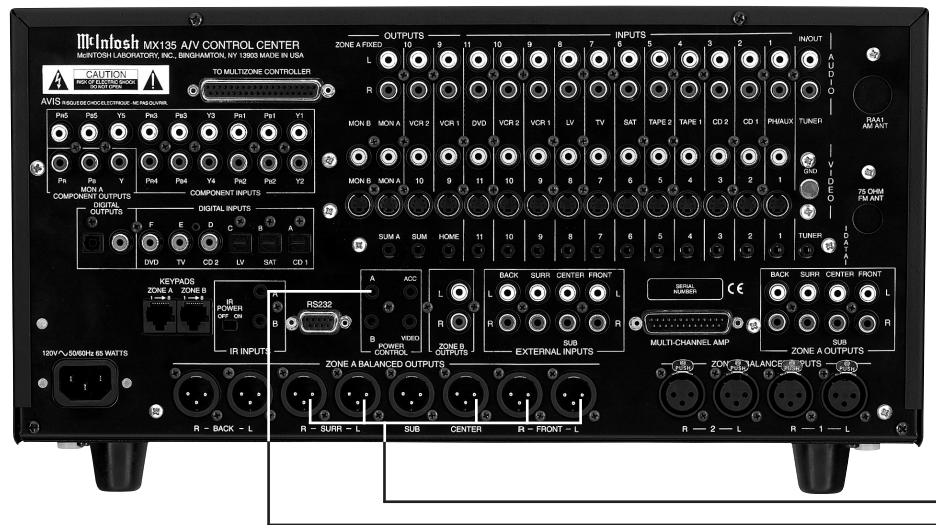

# How to Connect for Five Channels

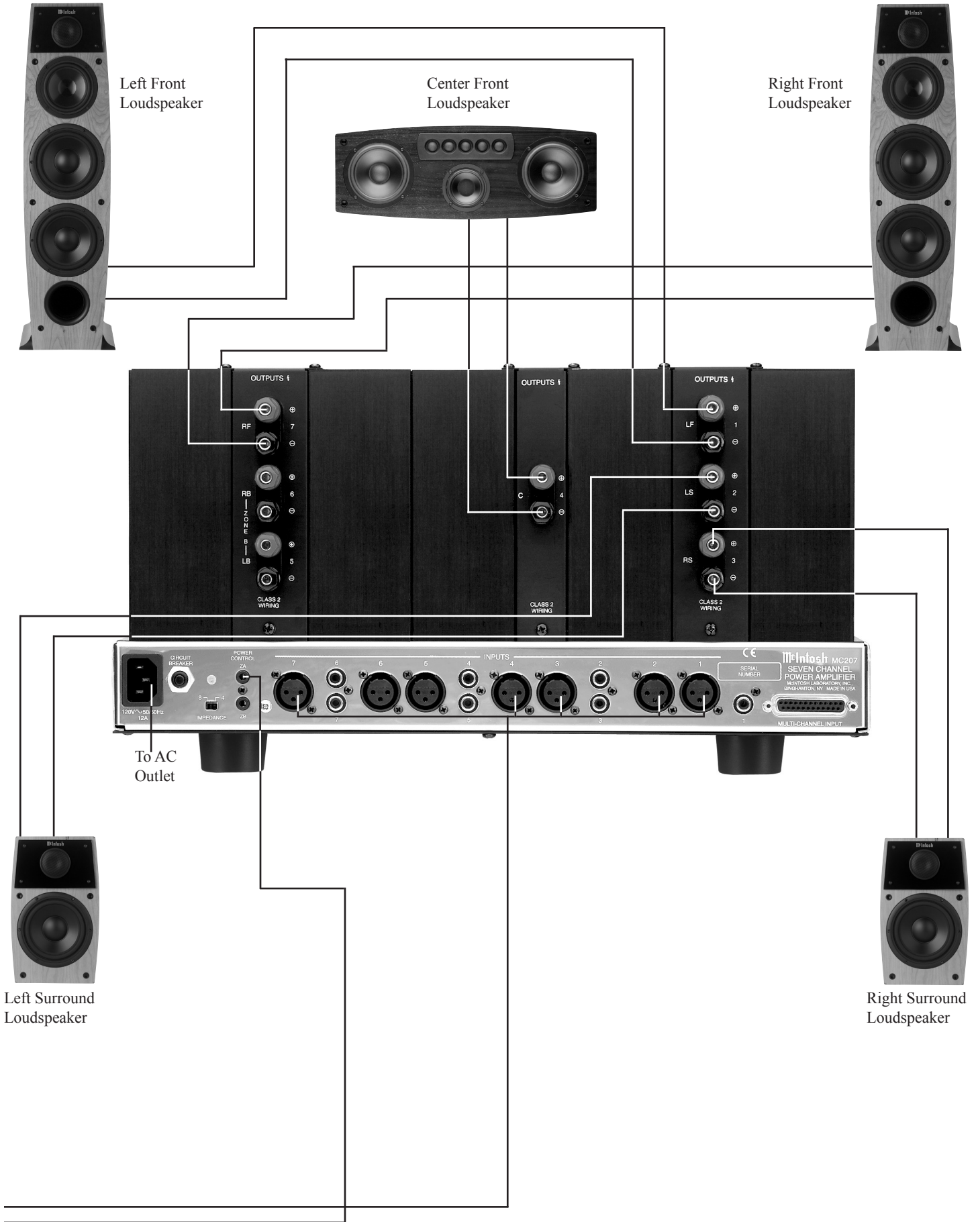



## How to Connect for Two Channels (Zone B)

**Caution:** The supplied AC Power Cord should not be connected to the Rear Panel of the MC207 Amplifier until after the Loudspeaker Connections have been made. Failure to observe this could result in Electric Shock.

1. Connect Audio Cables from the Zone B Outputs of a McIntosh A/V Control Center to the MC207 INPUTS (Channels 5 and 6), making sure to match up the channel identifications between both units.
2. For Remote Power Control and Power Saving Standby/Off (for additional information refer to page 15), connect a power control cable from the McIntosh A/V Control Center Zone B Power Control Out to the MC207 POWER CONTROL ZB.
3. Prepare the Loudspeaker Hookup Cables that attach to the MC207 Power Amplifier by choosing one of the methods below:

### Bare wire cable ends:

Carefully remove sufficient insulation from the cable ends, refer to figures 1, 2 & 3. If the cable is stranded, carefully twist the strands together as tightly as possible.

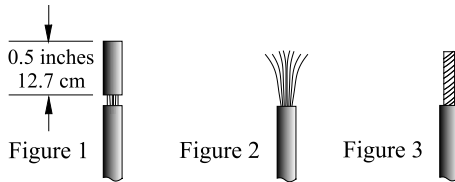

*Note: If desired, the twisted ends can be tinned with solder to keep the strands together, or attach spade lug and/or banana connector.*

### Spade lug or prepared wire connection:

Insert the spade lug connector or prepared section of the cable end into the terminal side access hole, and tighten the terminal cap until the cable is firmly clamped into the terminal so the wires cannot slip out. Refer to figures 4, 5 & 6.

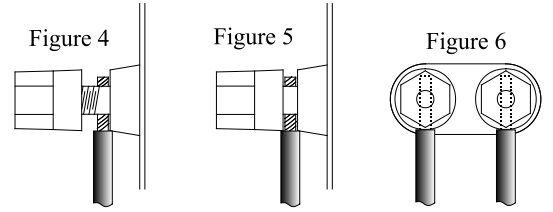

### Banana plug connection:

Tighten the top portion of the terminal post and insert the banana plug into the opening at the top of the terminal. Refer to figure 7.

*Note: The use of Banana Plugs is for use in the United States and Canada only.*

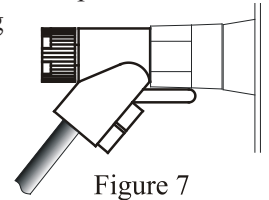

4. Connect the Loudspeaker Hookup Cables from the MC207 OUTPUT Terminals to the Loudspeakers, being careful to observe the correct polarities and channel designation.

**WARNING: Loudspeaker terminals are hazardous live and present a risk of electric shock. For additional instruction on making Loudspeaker Connections contact your McIntosh Dealer or McIntosh Technical Support.**

5. Place the IMPEDANCE Switch to the position (4 ohm or 8 ohm) that matches the impedance of the connected Loudspeakers. In the event that some of the Loudspeakers in the system are of different impedance, use the impedance of the Left and Right Front Loudspeakers to set the IMPEDANCE Switch position.
6. Connect the MC207 Power Cord to an active AC outlet.

McIntosh A/V Control Center

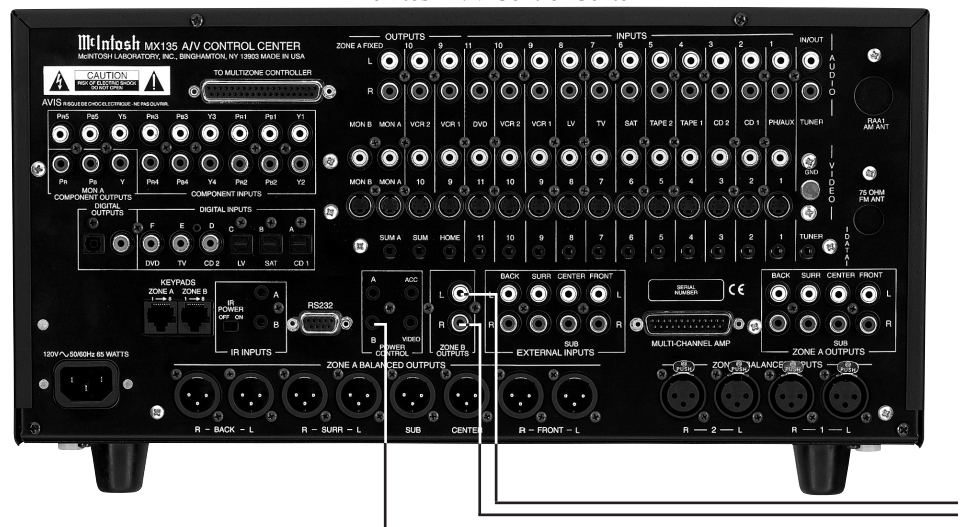

## How to Connect for Two Channels (Zone B)

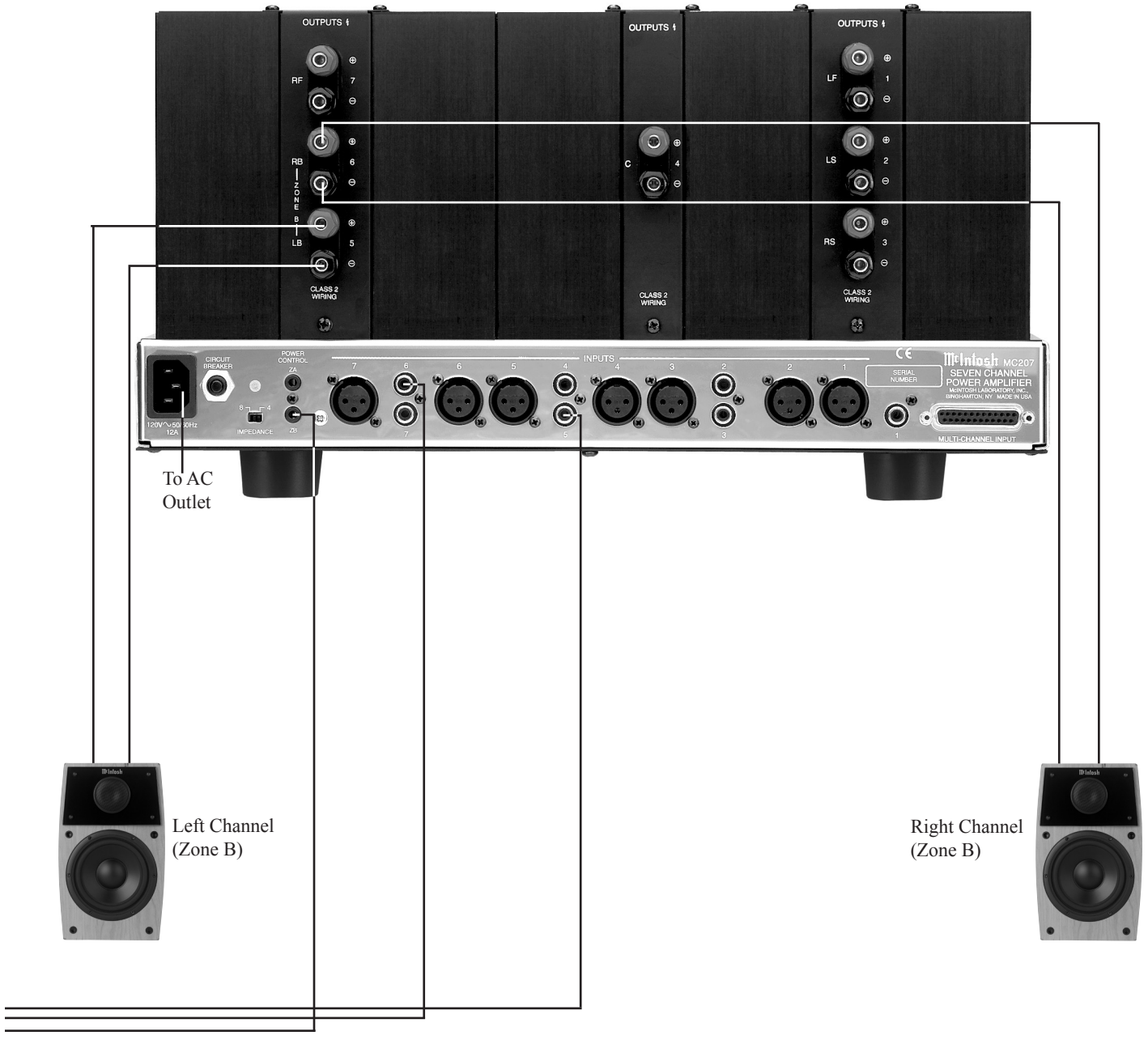



POWER OUTPUT METER indicates power output of the Left Front Channel (1)

POWER OUTPUT METER indicates power output of the Center Front Channel (4)

POWER OUTPUT METER indicates power output of the Right Front Channel (7)

POWER GUARD LED lights when the Left Front Channel (1) POWER GUARD Circuit activates

POWER GUARD LED lights when the Center Front Channel (4) POWER GUARD Circuit activates

POWER GUARD LED lights when the Right Front Channel (7) POWER GUARD Circuit activates



Remote On Indicator lights when the amplifier is in the Remote Turn-On Mode

POWER GUARD LEDs light when the Left Surround Channel (2), Right Surround Channel (3), Left Back Surround Channel (5) or Right Back Surround Channel (6) POWER GUARD Circuit activates

METER LIGHTS Switch selects the Meter Illumination On or Off

POWER Switch Turns AC Power Off, Remote (On/Off), or On

## How to Operate

### Power On

With the POWER Switch set to the REMOTE Position, the MC207 will turn On or Off when an A/V Control Center turns On or Off.

When connected to a McIntosh A/V Control (or Preamplifier) with the Power Save Feature set active, the MC207 will switch Off after a period of inactivity. For additional information please refer to the McIntosh A/V Control (or Preamplifier) Owner's Manual.

For manual operation, place the POWER Switch to the ON Position as desired. Refer to figure 8.



Figure 8

*Note: There must be a power control connection between the MC207 and the McIntosh A/V Control Center (or Preamplifier) in order for the remote power turn-on and Power Save feature to function.*

### Meter Illumination

Rotate the METER LIGHTS Switch to select Meter Illumination On or Off. Refer to figure 9.

*Note: When the MC207 is connected to a McIntosh MX132, MX134 or MX135 A/V Control Center with a DB25 conductor cable, the meter illumination will automatically switch On during the Loudspeaker Level Setup Adjustment.*

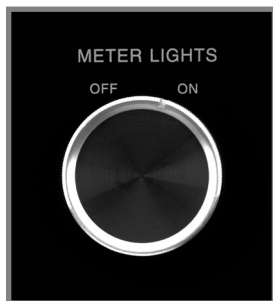

Figure 9

### Impedance Switch

The MC207's Dynamic Power Manager® Circuitry allows for the connection of either 4 ohm or 8 ohm Loudspeakers to its output terminals, while at the same time delivering the same power output. Refer to figure 10.

Place the IMPEDANCE Switch to the position (4 ohm or 8 ohm) that matches the impedance of the connected Loudspeakers. In the event that some of the Loudspeakers in the system are of different impedance, use the impedance of the Left and Right

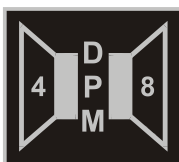

Figure 10

Front Loudspeakers to set the IMPEDANCE Switch position. Refer to figure 11.



Figure 11

## How to Read the Power Output Meters

The MC207 Power Output Meters are calibrated to allow for the direct reading of either the Power Output in Watts or Decibels going to the Front Left, Center and Right Loudspeakers. The meters respond to all the musical information being produced by the amplifier. They indicate to an accuracy of at least 95% of the power output with only a single cycle of a 2000Hz tone burst. Refer to figure 12.

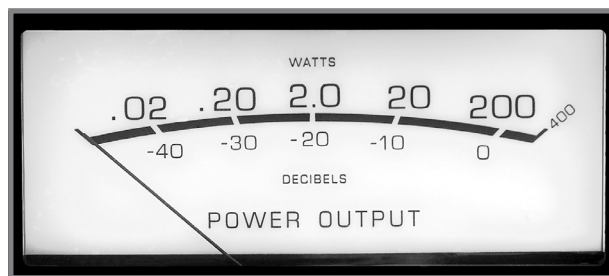

Figure 12



## Technical Description

McIntosh Laboratory, the company who introduced the world's first amplifier that could be called "High Fidelity", has done it again. The McIntosh engineering staff has created a power amplifier without compromise, using the most advanced McIntosh circuit design concepts.

A continuous average power output rating of 200 watts and an output current of greater than 25 amperes per channel, makes this one of the most advanced and powerful amplifiers McIntosh has ever manufactured. The distortion limits for the MC207 are no more than 0.005% at rated power output for all frequencies from 20Hz to 20,000Hz. Typical performance at mid frequencies is less than 0.002%. The true distortion readings on the MC207 are so low, it takes special measuring techniques to make accurate readings. The MC207 can deliver the best possible performance from any type of high quality Loudspeaker System.

Creating an amplifier with this level of performance did not come easily. Many months of design, testing and measuring were required. Extensive controlled listening tests, the ultimate form of measuring, were made before the final design was accepted.

### Design Philosophy

The design philosophy incorporated in the MC207 involved several different techniques, all based on sound scientific logic. Refer to figure 13. Every stage of voltage or current amplification must be as linear as possible prior to the use of negative feedback. McIntosh engineers know how to properly design negative feedback circuits so they contribute to the extremely low distortion performance expected from a McIntosh amplifier. The typical McIntosh owner would never accept the approximately 100 times higher distortion of many non-feedback designs.



Inside View of the MC207



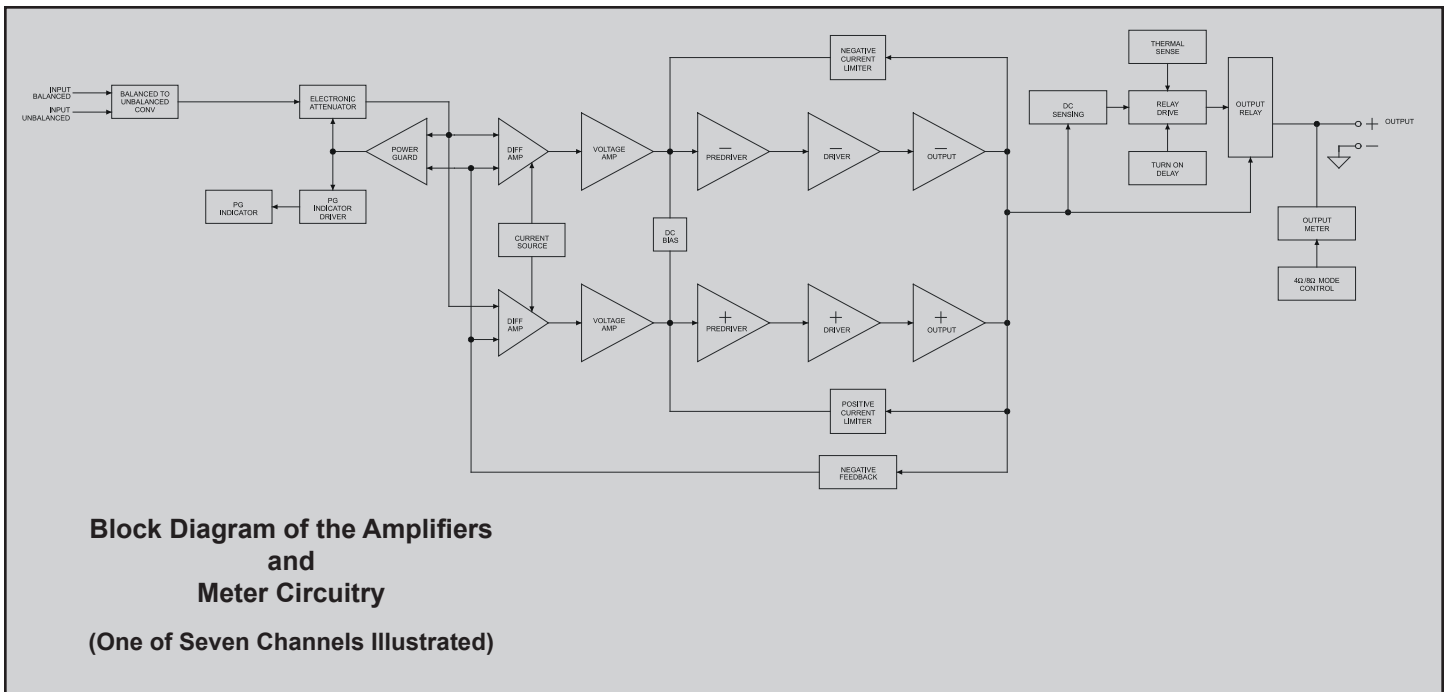

Figure 13

All transistors are selected to have nearly constant current gain over the entire current range they must cover. Output transistors in particular, have matched uniform current gain, high current-bandwidth product and large active region safe operating area. To accommodate the high current demands of a 4 ohm loudspeaker, the MC207 Output Circuitry utilizes a multiplicity of power output transistors. Refer to figure 14. An automatic tracking bias system completely eliminates any trace of crossover distortion. Precision metal film resistors and low dielectric absorption film capacitors are used in all critical circuit locations.

The MC207 is the first McIntosh Power Amplifier to use the newly developed Dynamic Power Manager® (DPM)

Circuitry. Refer to figure 15 on the next page. The MC207 can easily drive 4 ohm speakers, with their high current demand. Additionally, the MC207 can be used with 8 ohm

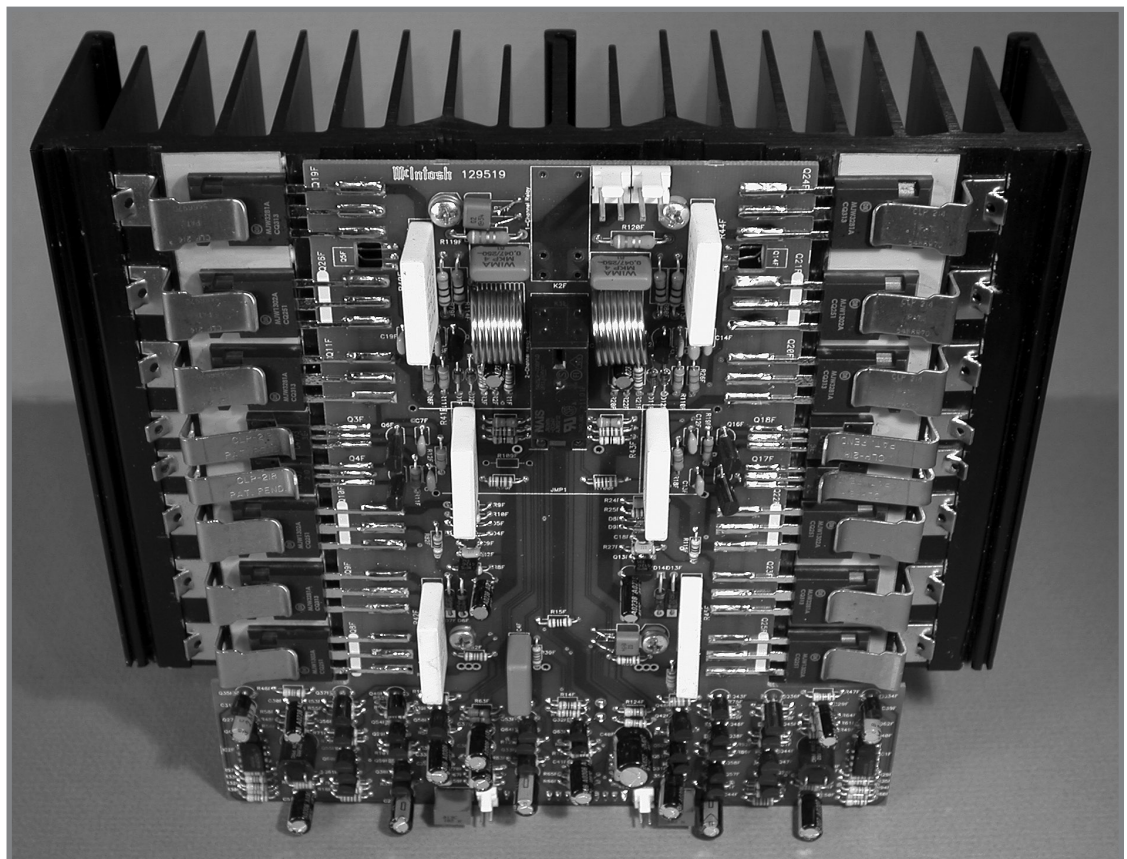

Figure 14

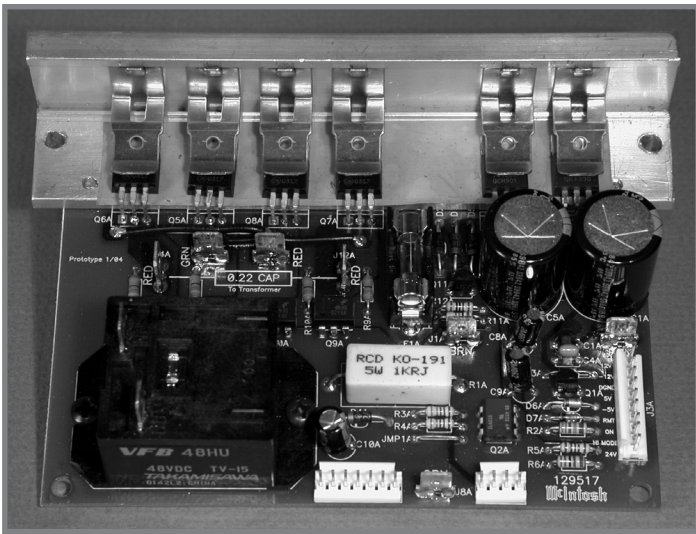

Figure 15

speakers, and deliver equal power. McIntosh's new DPM<sup>®</sup> design enables it to run on higher voltage rails when connected to less current-hungry 8 ohm speakers and still deliver 200 watts. The power penalty usually paid with 8 ohm speakers on high current amplifiers does not exist with this new design.

The high efficiency circuit design of the MC207 contributes to low operating temperatures. More than 2625 square inches of heat sink area occupies almost half of the MC207's chassis space and keeps the amplifier operating safely with convection cooling. No fans are needed. Refer to figure 16.

### Protection Circuits

The MC207 incorporates its version of the McIntosh Sentry Monitor output transistor protection circuit. Refer to figure 17. There is absolutely no compromise in sonic

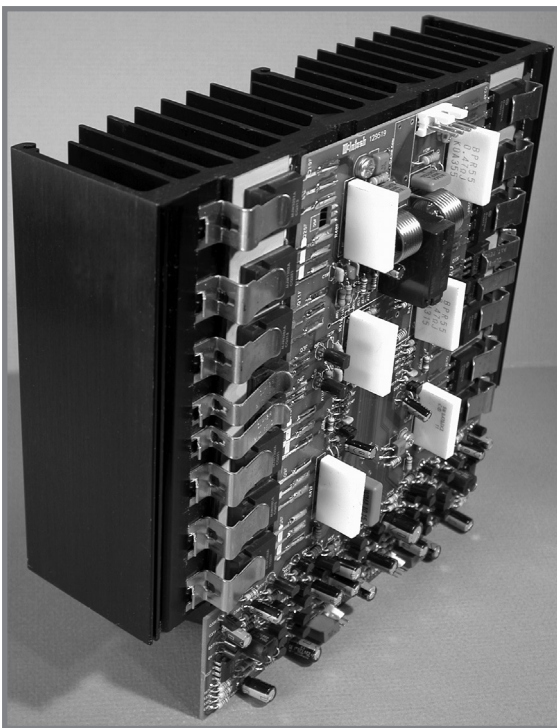

Figure 16

performance with this circuit, and it ensures safe operation of the amplifier under even the most extreme operating conditions. The different types of protection circuits incorporated in the MC207 insure a long and safe operating life.

The MC207 also includes the unique patented McIntosh Power Guard circuit.

Power Guard eliminates the possibility of ever overdriving the amplifier into clipping. Refer to figures 18, 19 and 20. An overdriven amplifier can produce both audible and inaudible distortion levels exceeding 40%. The audible distortion is unpleasant to hear, but the inaudible ultrasonic distortion is also undesirable, since it can damage valuable Loudspeaker System tweeters. You will never experience the harsh and damaging distortion due to clipping.

The Power Guard circuit

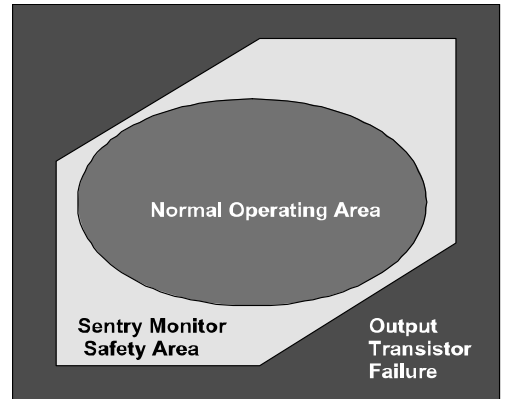

Figure 17

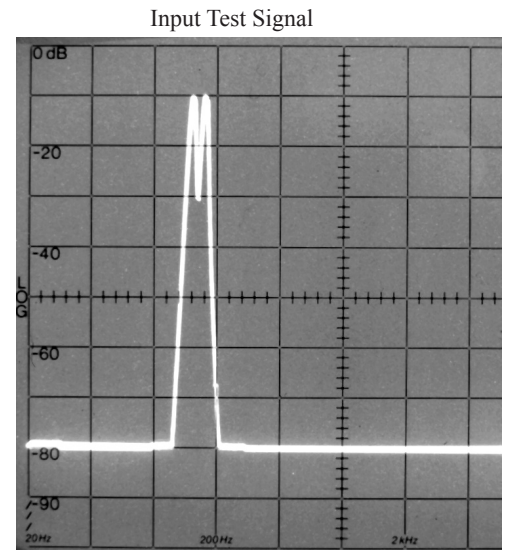

Figure 18

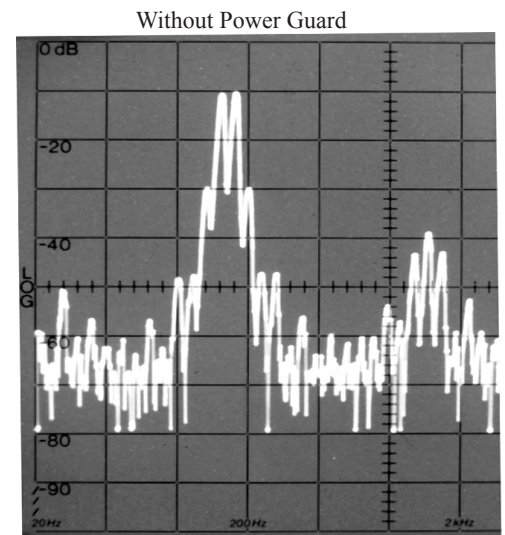

Figure 19

is a waveform comparator, monitoring both the input and output waveforms. Under normal operating conditions, there are no differences between the shape of these waveforms. If an amplifier channel is overdriven, there will be a difference

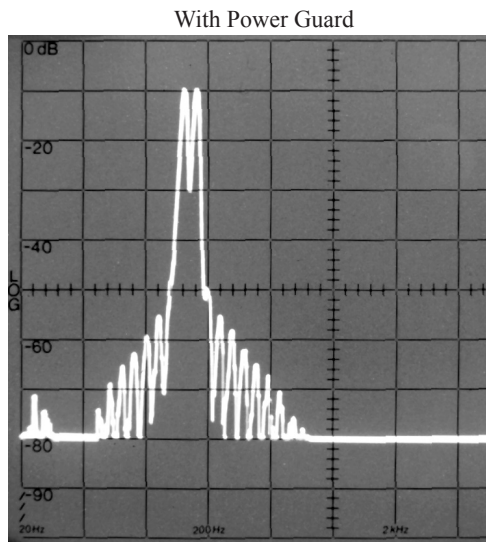

Figure 20

between the two signal waveforms. When the difference exceeds 0.3% (equivalent to 0.3% harmonic distortion), the Power Guard activates the PG light and a dynamic electronic attenuator at the amplifier input reduces the input volume just enough to prevent any further increase in distortion. The Power Guard circuit acts so fast that there are absolutely no audible side effects and the sonic purity of the music reproduction is perfectly preserved. The MC207 Power Amplifier with Power Guard is not limited to just the rated power output, but will actually produce distortion free output well above its rated power due to the McIntosh philosophy of conservative design.

**Power Supply Circuits**

To compliment the design of the MC207, there is a high current power supply for the seven power amplifier chan-

nels. Refer to figure 21. The very large Power Transformer, has toroidal windings on a toroidal core and can supply over 35 amps of continuous current. Refer to figure 22

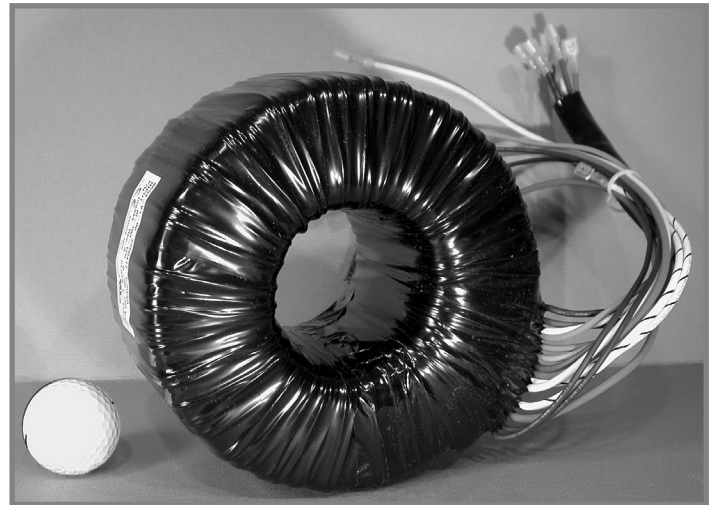
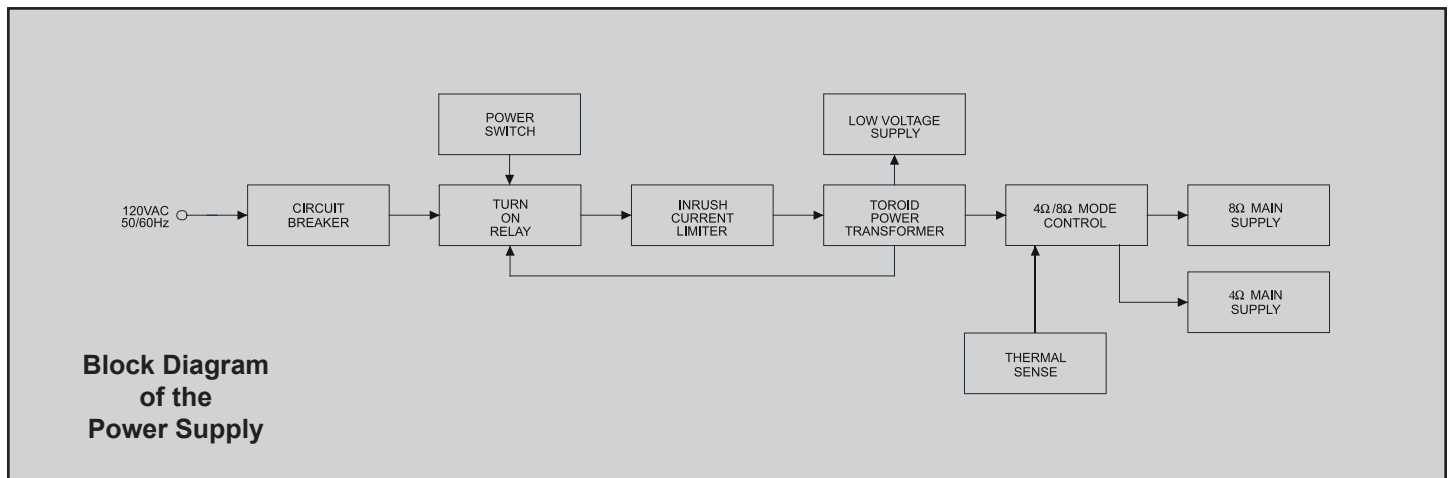

Figure 22

(golf ball is for size comparison). It is enclosed in the legendary McIntosh Potted Enclosures and weighs over 12.06kg. The super size main filter capacitors can store over 430 Joules of energy for the seven amplifier channels, necessary for the wide dynamic range that “Digital Audio” demands. Refer to figure 23 on the next page. The power amplifier draws high current from the AC power line. Therefore, it is important that they plug directly into the wall outlet.

Also, most owners desire one power switch for the whole audio system. The MC207 is equipped with a circuit that provides remote Power Control from a McIntosh A/V Control Center. When the A/V Control Center is switched On a digital “1” (+5V) signal operates the power relay in



**Block Diagram  
of the  
Power Supply**

Figure 21

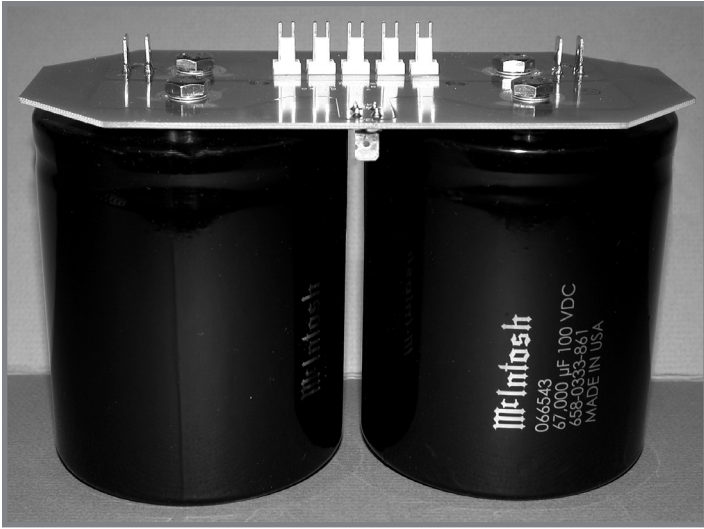
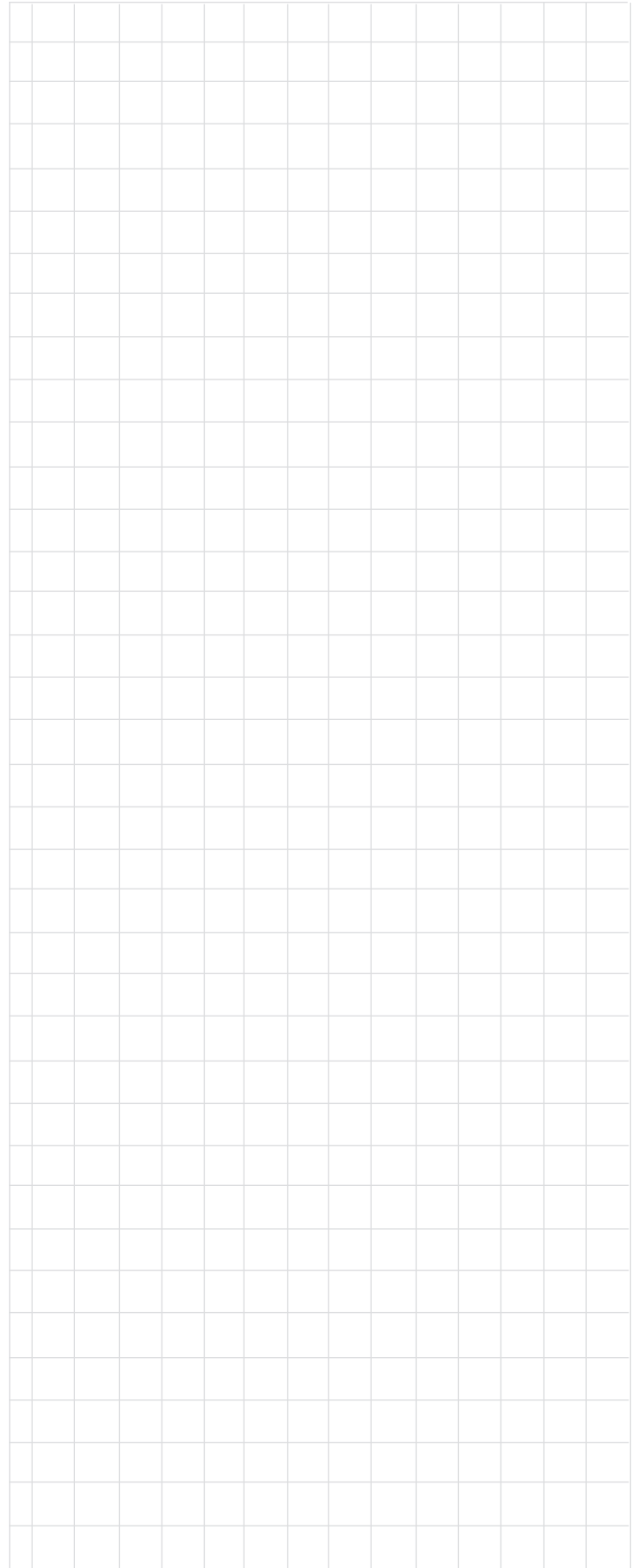
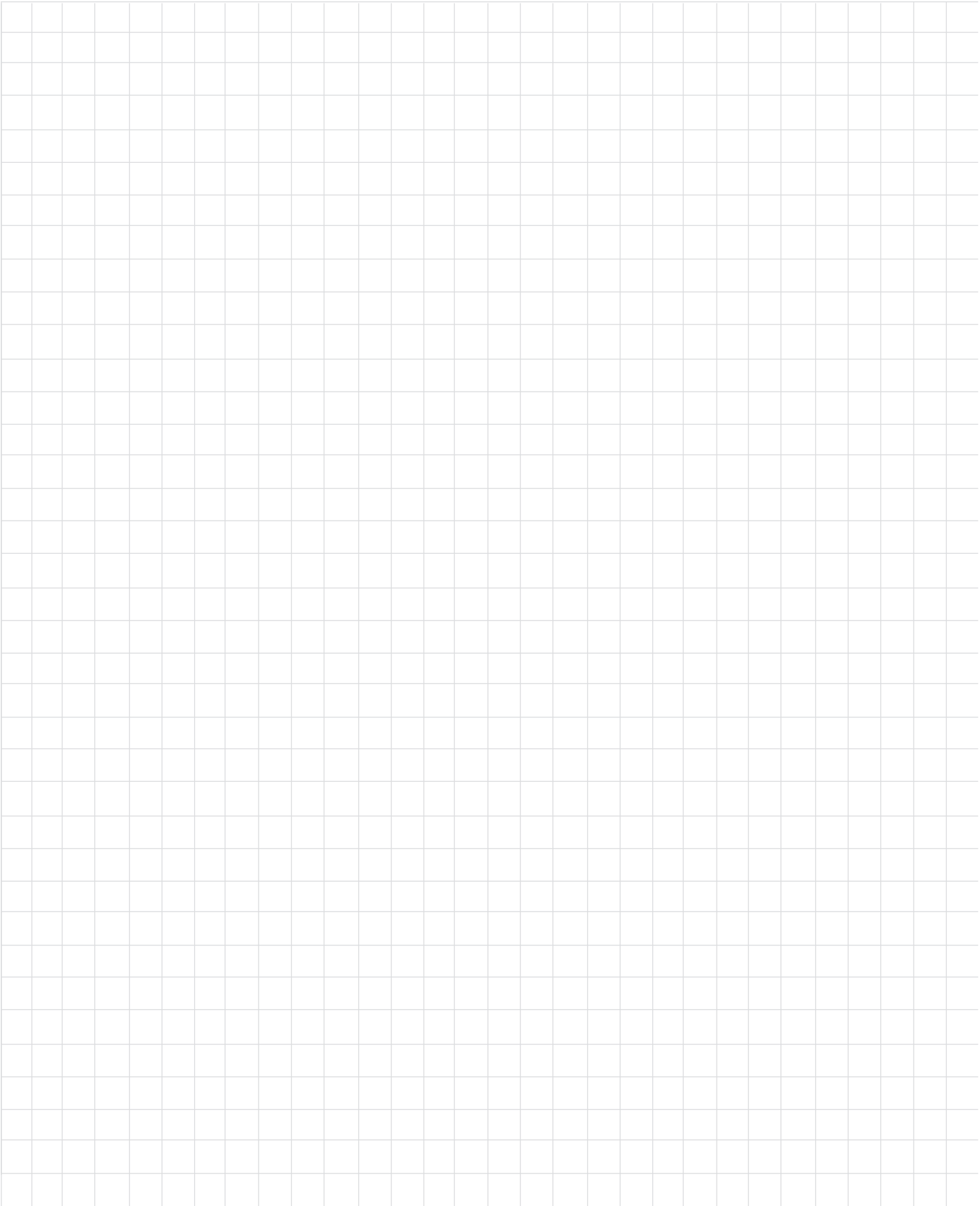

Figure 23

the MC207. The MC207 also has a remote Power Control input for Zone B operation (two of the seven channels).







## Specifications

---

### Power Output

Minimum sine wave continuous average power output per channel, all channels operating is:  
200 watts into a 4 ohm or 8 ohm load

### Rated Power Band

20Hz to 20,000Hz

### Total Harmonic Distortion

Maximum Total Harmonic Distortion at any power level from 250 milliwatts to rated power output is:  
0.005% for 4 or 8 ohm loads

### Dynamic Headroom

1.7dB

### Frequency Response

+0, -0.25dB from 20Hz to 20,000Hz  
+0, -3dB from 10Hz to 100,000Hz

### Sensitivity

1.0 Volt Unbalanced with a 4 ohm Loudspeaker  
2.0 Volt Balanced with a 4 ohm Loudspeaker  
1.4 Volt Unbalanced with a 8 ohm Loudspeaker  
2.8 Volt Balanced with a 8 ohm Loudspeaker

### A-Weighted Signal To Noise Ratio

89dB (112dB below rated output)

### Intermodulation Distortion

Maximum Intermodulation Distortion if instantaneous peak output per channel does not exceed twice the rated output, for any combination of frequencies from 20Hz to 20,000Hz, with all channels operating is:  
0.005% for 4 or 8 ohm loads

### Input Impedance

20,000 ohms Balanced  
10,000 ohms Unbalanced

### Wide Band Damping Factor

Greater than 60 at 4 ohms  
Greater than 140 at 8 ohms

### Power Requirements

100 Volts, 50/60Hz at 1440 watts  
110 Volts, 50/60Hz at 13.0 amps  
120 Volts, 50/60Hz at 12.0 amps  
220 Volts, 50/60Hz at 7.5 amps  
230 Volts, 50/60Hz at 6.5 amps  
240 Volts, 50/60Hz at 6.5 amps

*Note: Refer to the rear panel of the MC207 for the correct voltage.*

### Overall Dimensions

17-1/2 inches (44.45cm) W, 9-7/16 inches (23.97cm) H,  
18-3/4 inches (47.63cm) D, including clearance for connectors

### Weight

83 pounds (37.6 kg) net, 116 pounds (52.6 kg) in shipping carton

**Packing Instructions**

In the event it is necessary to repack the equipment for shipment, the equipment must be packed exactly as shown below. It is very important that the four plastic feet are attached to the bottom of the equipment. Four 1/4 - 20 x 2-1/2 inch screws and washers must be used to fasten the unit securely to the bottom pad and shipping skid. This will ensure the proper equipment location on the bottom pad. Failure to do this will result in shipping damage.

Use the original shipping carton and interior parts only if they are all in good serviceable condition. If a shipping carton or any of the interior part(s) are needed, please call or write Customer Service Department of McIntosh Laboratory. Please see the Part List for the correct part numbers.

Quantity	Part Number	Description
1	034052	Shipping carton top
1	034051	Shipping carton bottom
2	034054	Foam Pad (top and bottom)
2	034186	Foam Pad (front and rear)
2	034187	Foam Pad (sides)
1	034136	Inner carton top
1	034137	Inner carton bottom
1	034188	Foam Pad (inner carton)
1	034264	Shipping skid
4	101212	1/4 - 20x2-1/4 cap screw
4	104058	Flat washer

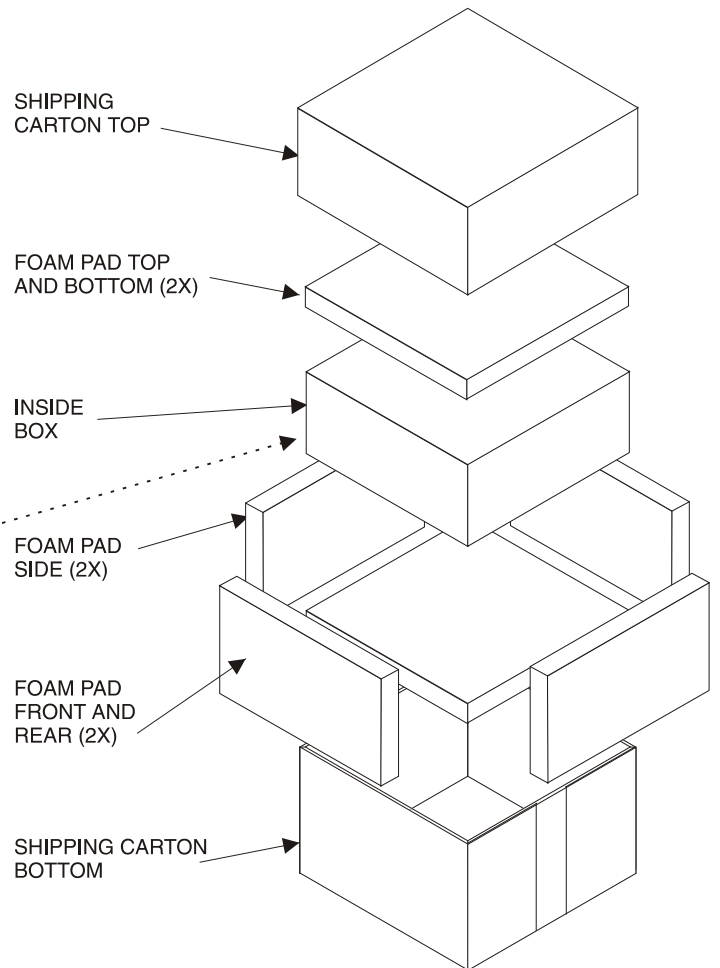
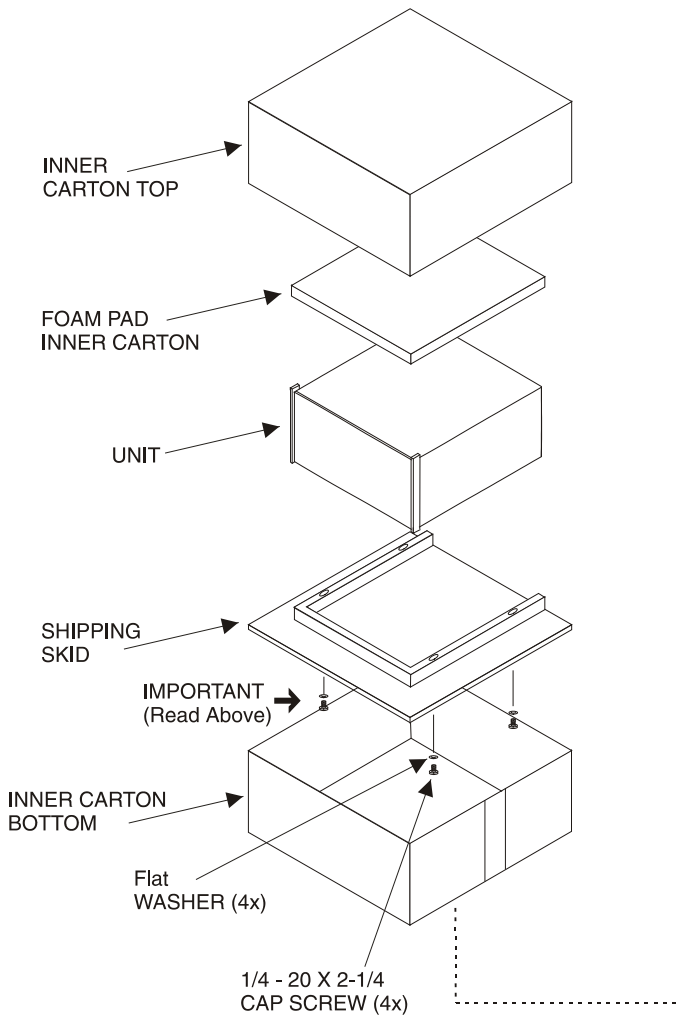



McIntosh Laboratory, Inc.  
2 Chambers Street  
Binghamton, NY 13903

The continuous improvement of its products is the  
policy of McIntosh Laboratory Incorporated who  
reserve the right to improve design without notice.  
Printed in the U.S.A.

McIntosh Part No. 04089602